

Public-law institution jointly founded by the federal states and the Federation

European Technical Assessment Body
for construction products



European Technical Assessment

ETA-21/0799
of 28 March 2024

English translation prepared by DIBt - Original version in German language

General Part

Technical Assessment Body issuing the European Technical Assessment:

Deutsches Institut für Bautechnik

Trade name of the construction product

ZENTOR® - Rebar Splicing System

Product family to which the construction product belongs

Couplers for mechanical splices of reinforcing steel bars

Manufacturer

DUCA Systems AG
Allmendstrasse 2
8105 Regensdorf
SCHWEIZ

Manufacturing plant

DUCA Systems AG
Allmendstrasse 2
8105 Regensdorf
SCHWEIZ

This European Technical Assessment contains

22 pages including 3 annexes which form an integral part of this assessment

This European Technical Assessment is issued in accordance with Regulation (EU) No 305/2011, on the basis of

EAD 160129-00-0301, Edition 01/2020

This version replaces

ETA-21/0799 issued on 25 November 2021

The European Technical Assessment is issued by the Technical Assessment Body in its official language. Translations of this European Technical Assessment in other languages shall fully correspond to the original issued document and shall be identified as such.

Communication of this European Technical Assessment, including transmission by electronic means, shall be in full. However, partial reproduction may only be made with the written consent of the issuing Technical Assessment Body. Any partial reproduction shall be identified as such.

This European Technical Assessment may be withdrawn by the issuing Technical Assessment Body, in particular pursuant to information by the Commission in accordance with Article 25(3) of Regulation (EU) No 305/2011.

Specific Part

1 Technical description of the product

The ZENTOR® - Rebar Splicing System is used as a mechanical, screwed system for connecting reinforcing bars in reinforced concrete components and for connecting to steel components under static or quasi-static, fatigue and low cycle loading.

The product description is given in Annex A.

The characteristic material values, dimensions and tolerances of ZENTOR® - Rebar Splicing System not indicated in Annexes A1 to A8 shall correspond to the respective values laid down in the technical documentation^[1] of this European technical assessment.

2 Specification of the intended use in accordance with the applicable European Assessment Document

The performances given in Section 3 are only valid if the ZENTOR® - Rebar Splicing System is used in compliance with the specifications and conditions given in Annex B.

The verifications and assessment methods on which this European Technical Assessment is based lead to the assumption of a working life of the ZENTOR® - Rebar Splicing System of at least 100 years. The indications given on the working life cannot be interpreted as a guarantee given by the producer, but are to be regarded only as a means for choosing the right products in relation to the expected economically reasonable working life of the works.

3 Performance of the product and references to the methods used for its assessment

3.1 Mechanical resistance and stability (BWR 1)

Essential characteristic	Performance
Resistance to static or quasi-static loading	See Annex C1 – C7
Slip under static or quasi-static load	See Annex C1 – C7
Slip after static or quasi-static load	See Annex C1 – C7
Fatigue strength for $N = 2 \cdot 10^6$ load cycles	See Annex C1
Fatigue strength for S-N curve with k_1 and k_2 according to EN 1992-1-1	No performance assessed
Fatigue strength for S-N curve with specific k_1 and k_2	No performance assessed
Resistance to low cycle loading (seismic actions)	See Annex C1

3.2 Safety in case of fire (BWR 2)

Essential characteristic	Performance
Reaction to fire	Class A1

^[1] The technical documentation of this European technical assessment is deposited at the Deutsches Institut für Bautechnik and, as far as relevant for the tasks of the approved bodies involved in the attestation of conformity procedure, is handed over to the approved bodies.

4 Assessment and verification of constancy of performance (AVCP) system applied, with reference to its legal base

In accordance with EAD 160129-00-0301 the applicable European legal act is: 2000/606/EC.

The system to be applied is: 1+

5 Technical details necessary for the implementation of the AVCP system, as provided for in the applicable EAD

Technical details necessary for the implementation of the AVCP system are laid down in the control plan deposited with Deutsches Institut für Bautechnik.

The following standards are referred to in this European Technical Assessment:

- EN 1090-1:2009 + A1:2011 Execution of steel structures and aluminium structures - Part 1: Requirements for conformity assessment of structural components
- EN 1992-1-1:2004 + AC:2010 + A1:2014 Eurocode 2: Design of concrete structures - Part 1-1: General rules and rules for buildings
- EN 1998-1:2004 + AC:2009 + A1:2013 Eurocode 8: Design of structures for earthquake resistance - Part 1: General rules, seismic actions and rules for buildings
- EN ISO 9606-1:2017 Qualification testing of welders - Fusion welding - Part 1: Steels (ISO 9606-1:2012, including Cor 1:2012 and Cor 2:2013)
- EN ISO 12944-5:2019 Paints and varnishes - Corrosion protection of steel structures by protective paint systems - Part 5: Protective paint systems (ISO 12944-5:2019)
- EN ISO 15609-1:2019 Specification and qualification of welding procedures for metallic materials - Welding procedure specification - Part 1: Arc welding (ISO 15609-1:2019)

Issued in Berlin on 28 March 2024 by Deutsches Institut für Bautechnik

Dipl.-Ing. Beatrix Wittstock
Head of Section

beglaubigt:
Kisan

Standard Connection ,S'

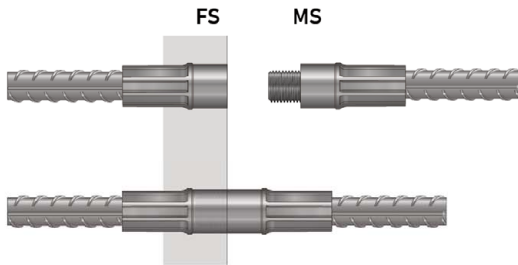

Bridge Connection ,B'

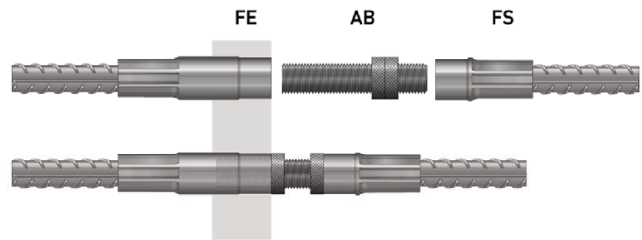

Female Reduction Connection ,F'

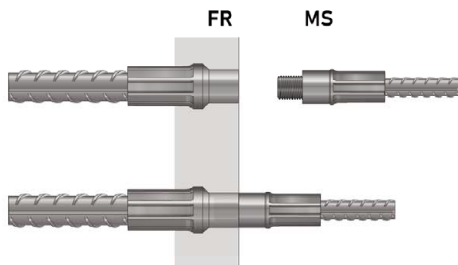

Transition Connection ,T'

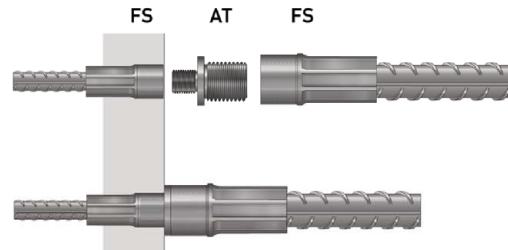

Left/Right Connection ,L'

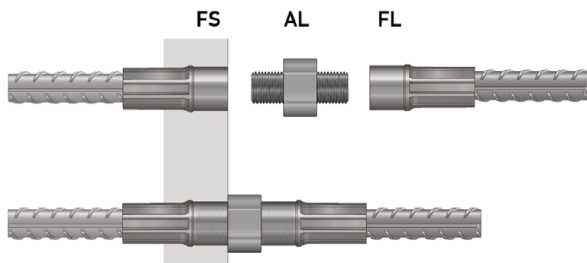

Coupler Connection ,C'

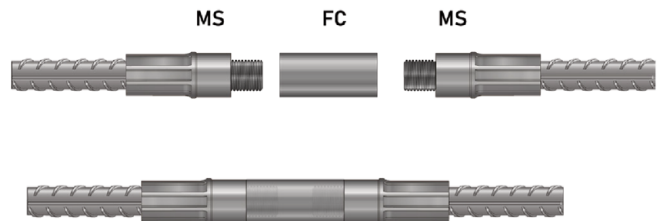

Welding Connection ,W'

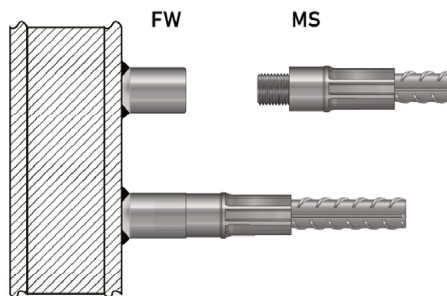

ZENTOR® - Rebar Splicing System

Product Discription - Type Overview

Annex A1

Connection of bars with the same diameter, which are freely rotatable

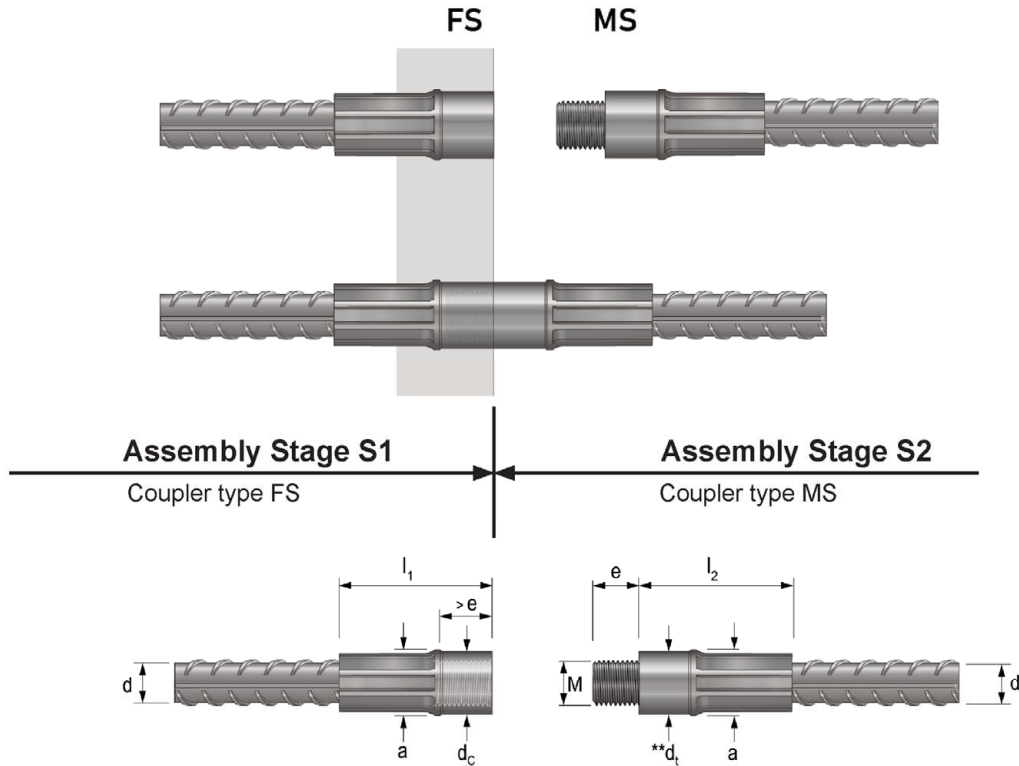

Coupler type		Rebar diameter d [mm]	Thread size M	Thread length e [mm]	Outer-Ø a [mm]	Outer-Ø (female) dc [mm]	Coupler length	
							l ₁ [mm]	l ₂ [mm]
FS10	MS10	10	M12	13.5	17.5	16.1	48	48
FS12	MS12	12	M16	16.5	21.0	20.5	55	55
FS14	MS14	14	M18	20.0	25.0	23.9	66	66
FS16	MS16	16	M20	21.0	28.0	26.9	72	72
FS18	MS18	18	M22	24.0	31.0	29.2	79	79
FS20	MS20	20	M24	25.0	34.0	32.2	87	87
FS22	MS22	22	M27	26.0	37.5	36.0	91	91
FS26 *	MS26 *	25 / 26	M30	30.5	44.0	41.1	111	111
FS28	MS28	28	M33	31.5	48.0	45.5	117	117
FS30	MS30	30	M36	35.5	51.0	48.4	126	126
FS32	MS32	32	M39	36.5	54.0	52.1	131	131
FS34	MS34	34	M42	39.0	58.0	56.1	142	142
FS36	MS36	36	M42	40.0	61.0	57.8	150	150
FS40	MS40	40	M48	44.5	67.5	64.9	164	164

* Type 26 can be used for rebar Ø25mm & 26mm

** Dimension d_i = d_c - 0.50mm

ZENTOR® - Rebar Splicing System

Product Description - Standard Connection 'S'

Annex A2

Connection of bars with the same diameter, which are not freely rotatable and conditionally axially displaceable

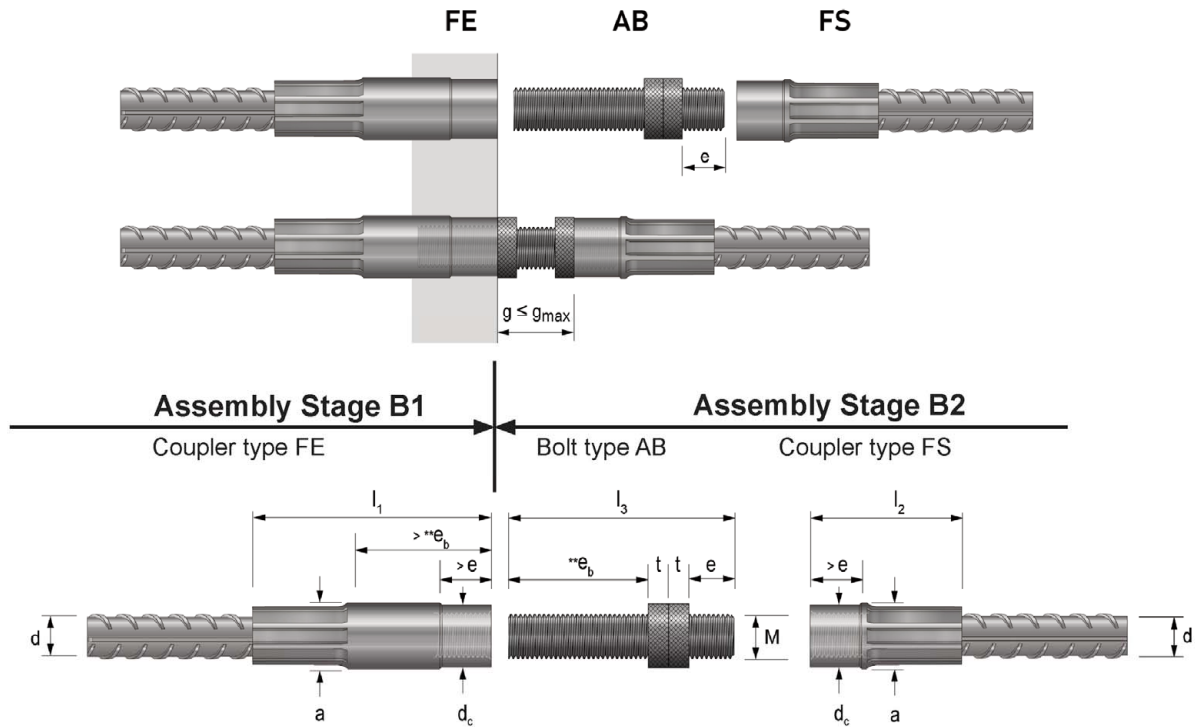

Coupler-/ bolt type			Rebar - Ø d [mm]	Thread size M	Thread length e [mm]	Outer-Ø (female)		Nuts wide t [mm]	Coupler-/ bolt length			g _{max} [mm]
						a [mm]	d _c [mm]		l ₁ [mm]	l ₃ [mm]	l ₂ [mm]	
FE10	AB10	FS10	10	M12	13.5	17.5	16.1	7.0	71	65.5	48	38.5
FE12	AB12	FS12	12	M16	16.5	21.0	20.5	7.0	83	76.5	55	43.5
FE14	AB14	FS14	14	M18	20.0	25.0	23.9	8.0	100	91.0	66	51
FE16	AB16	FS16	16	M20	21.0	28.0	26.9	8.0	110	96.0	72	54
FE18	AB18	FS18	18	M22	24.0	31.0	29.2	10.0	121	111.0	79	63
FE20	AB20	FS20	20	M24	25.0	34.0	32.2	10.0	132	116.0	87	66
FE22	AB22	FS22	22	M27	26.0	37.5	36.0	10.0	139	121.0	91	69
FE26*	AB26	FS26*	25 / 26	M30	30.5	44.0	41.1	12.0	165	142.5	111	81.5
FE28	AB28	FS28	28	M33	31.5	48.0	45.5	12.0	174	147.5	117	84.5
FE30	AB30	FS30	30	M36	35.5	51.0	48.4	15.0	190	167.5	126	96.5
FE32	AB32	FS32	32	M39	36.5	54.0	52.1	15.0	201	172.5	131	99.5
FE34	AB34	FS34	34	M42	39.0	58.0	56.1	16.0	215	184.0	142	106
FE36	AB36	FS36	36	M42	40.0	61.0	57.8	16.0	222	189.0	150	109
FE40	AB40	FS40	40	M48	44.5	67.5	64.9	18.0	243	210.5	164	121.5

* Type 26 can be used for rebar Ø25mm & 26mm ** e_b = l₃ - e - 2·t

ZENTOR® - Rebar Splicing System

Product Description - Bridge Connection 'B'

Annex A3

Connection of bars with different nominal diameter, which are freely rotatable

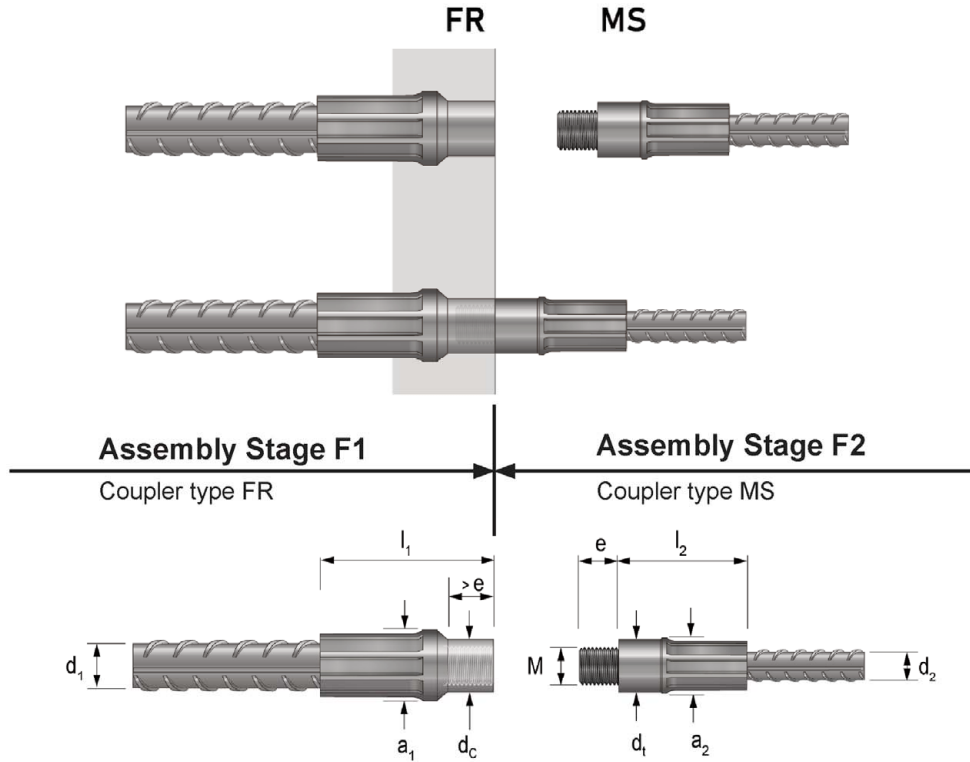

Coupler type	Rebar diameter		Thread size M	Thread length e [mm]	Outer- Ø female dc [mm]	Outer- Ø male dt [mm]	Outer- Ø a1 [mm]	Coupler length l1 [mm]	Outer- Ø a2 [mm]	Coupler length l2 [mm]	further possible combinations with FR: MS..	
	d1 [mm]	min. d2 [mm]										
FR1210	MS10	12	10	M12	13.5	18.2	15.6	21.0	54	17.5	48	-
FR1410	MS10	14	10	M12	13.5	20.9	15.6	25.0	64	17.5	48	12
FR1612	MS12	16	12	M16	16.5	24.8	20.0	28.0	69	21.0	55	14
FR1812	MS12	18	12	M16	16.5	26.3	20.0	31.0	76	21.0	55	14/16
FR2014	MS14	20	14	M18	20.0	28.9	23.4	34.0	87	25.0	66	16/18
FR2216	MS16	22	16	M20	21.0	32.1	26.4	37.5	91	28.0	72	18/20
FR2620*	MS20	25 / 26	20	M24	25.0	37.9	31.7	44.0	109	34.0	87	22
FR2820	MS20	28	20	M24	25.0	40.6	31.7	48.0	117	34.0	87	22/25/26
FR3020	MS20	30	20	M24	25.0	42.1	31.7	51.0	126	34.0	87	22/25/26
FR3226*	MS26*	32	25 / 26	M30	30.5	46.9	40.6	54.0	132	44.0	111	25/28
FR3426*	MS26*	34	25 / 26	M30	30.5	49.5	40.6	58.0	143	44.0	111	25/30
FR3628	MS28	36	28	M33	31.5	53.0	45.0	61.0	147	48.0	117	30/32
FR4030	MS30	40	30	M36	35.5	58.3	47.9	67.5	164	51.0	126	32/34/36

* Type 26 can be used for rebar Ø25mm & 26mm

ZENTOR® - Rebar Splicing System

Product Description - Female Reduction 'F'

Annex A4

Connection of bars with different or same nominal diameter, which are freely rotatable

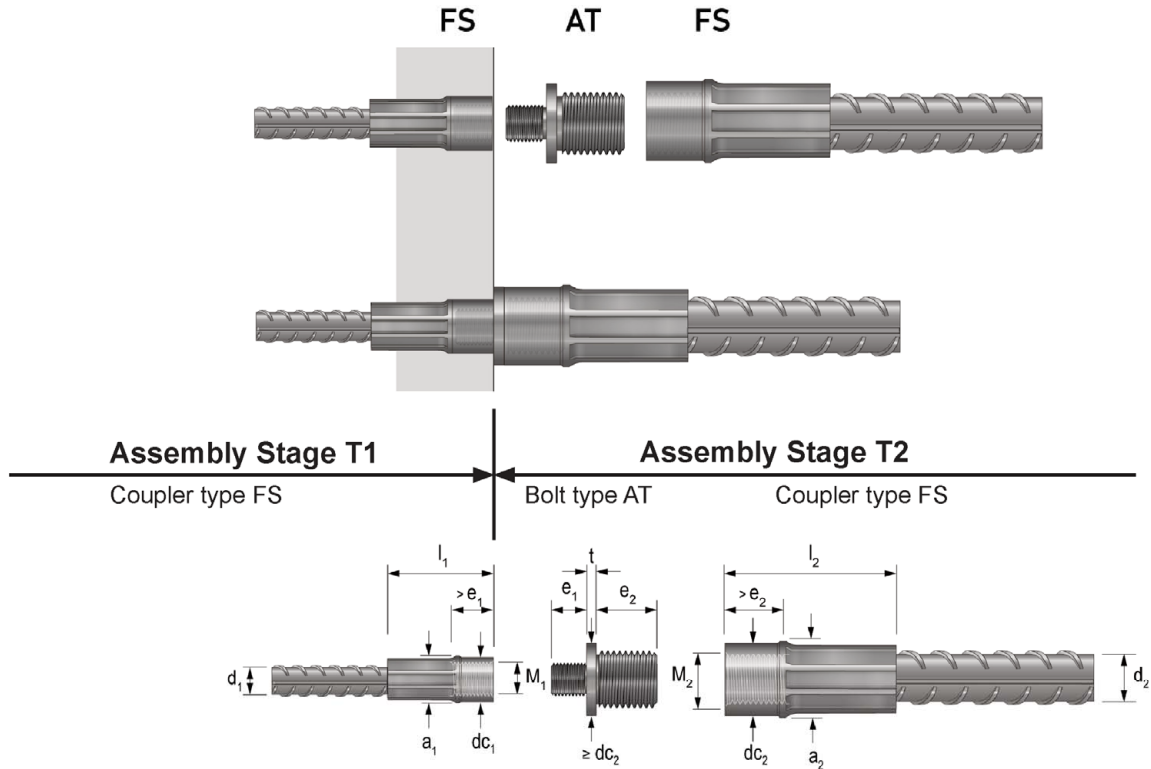

Coupler-/ bolt type			Rebar diameter		Coupler 1			Thread 1			Coupler 2			Thread2		Further possible combinations of d1 (exemplarily)
			d ₁ [mm]	max. d ₂ [mm]	a ₁ [mm]	dc ₁ [mm]	l ₁ [mm]	M1	e ₁ [mm]	t [mm]	a ₂ [mm]	dc ₂ [mm]	l ₂ [mm]	M2	e ₂ [mm]	
FS10	AT1012	FS12	10	12	17.5	16.1	47.5	M12	13.5	3	21.0	20.5	54.6	M16	16.5	10
FS10	AT1014	FS14	10	14	17.5	16.1	47.5	M12	13.5	4	25.0	23.9	65.8	M18	20.0	10 - 12
FS12	AT1216	FS16	12	16	21.0	20.5	54.6	M16	16.5	4	28.0	26.9	71.7	M20	21.0	12 - 14
FS12	AT1218	FS18	12	18	21.0	20.5	54.6	M16	16.5	5	31.0	29.2	79.5	M22	24.0	12 - 16
FS14	AT1420	FS20	14	20	25.0	23.9	65.8	M18	20.0	5	34.0	32.2	87.2	M24	25.0	14 - 18
FS16	AT1622	FS22	16	22	28.0	26.9	71.7	M20	21.0	5	37.5	36.0	91.0	M27	26.0	16 - 20
FS20	AT2026	FS26*	20	26	34.0	32.2	87.2	M24	25.0	5	44.0	41.1	110.9	M30	30.5	20 - 25
FS20	AT2028	FS28	20	28	34.0	32.2	87.2	M24	25.0	5	48.0	45.5	116.6	M33	31.5	20 - 26
FS20	AT2030	FS30	20	30	34.0	32.2	87.2	M24	25.0	5	51.0	48.4	126.1	M36	35.5	20 - 28
FS26*	AT2632	FS32	25 /26	32	44.0	41.1	110.9	M30	30.5	5	54.0	52.1	130.9	M39	36.5	25 - 30
FS26*	AT2634	FS34	25/26	34	44.0	41.1	110.9	M30	30.5	5	58.0	56.1	142.1	M42	39.0	25 - 32
FS28	AT2836	FS36	28	36	48.0	45.5	116.6	M33	31.5	5	61.0	57.8	149.7	M42	40.0	28 - 34
FS30	AT3040	FS40	30	40	51.0	48.4	126.1	M36	35.5	5	67.5	64.9	163.5	M48	44.5	30 - 40

* Type 26 can be used for rebar Ø25mm & 26mm

With the appropriate transition bolt type "AT", female ZENTOR® couplers of any size can be connected to one another.

ZENTOR® - Rebar Splicing System

Product Description - Coupler Transition Connection 'T'

Annex A5

Connection of bars with the same diameter, which are not freely rotatable

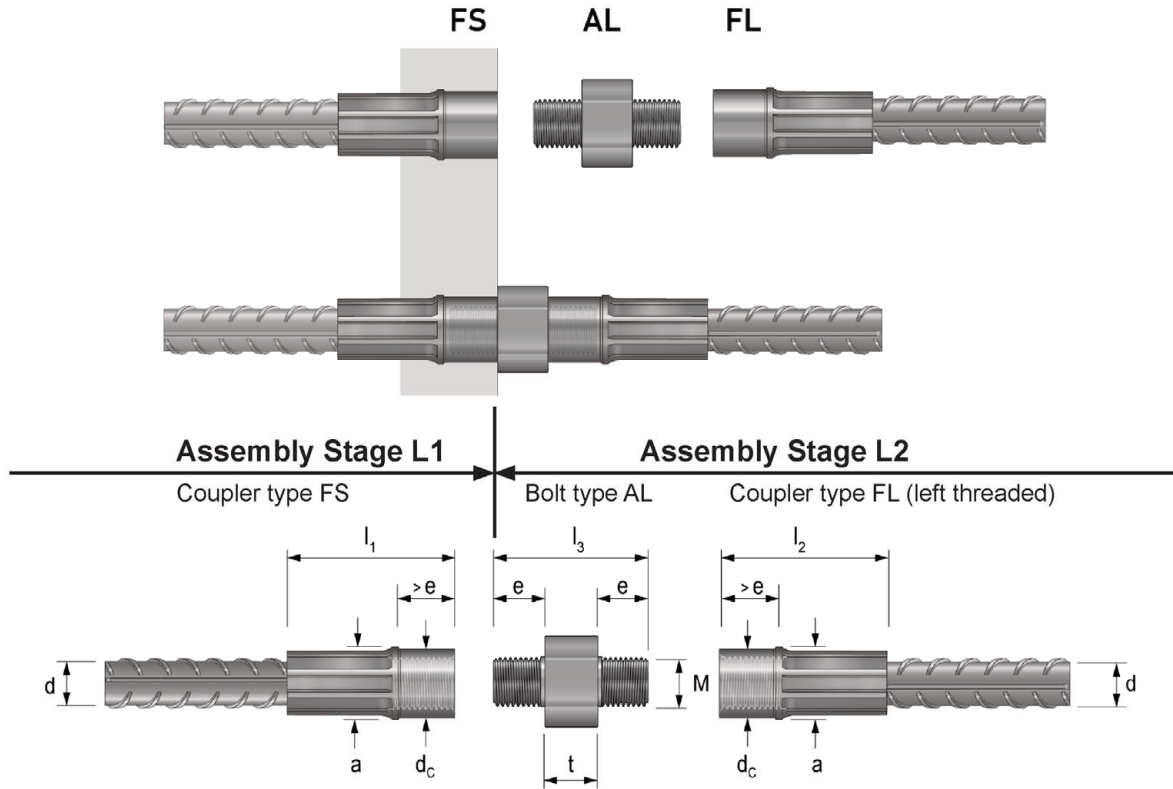

Coupler-/ bolt type			Rebar diameter d [mm]	Thread size M	Thread length e [mm]	Outer-Ø d _c [mm]	Outer-Ø a [mm]	Nut wide t [mm]	Coupler-/ bolt length		
									l ₁ [mm]	l ₃ [mm]	l ₂ [mm]
FS10	AL10	FL10	10	M12	13.5	16.1	17.5	15.0	48	42	48
FS12	AL12	FL12	12	M16	16.5	20.5	21.0	16.0	55	49	55
FS14	AL14	FL14	14	M18	20.0	23.9	25.0	16.0	66	56	66
FS16	AL16	FL16	16	M20	21.0	26.9	28.0	18.0	72	60	72
FS18	AL18	FL18	18	M22	24.0	29.2	31.0	19.0	79	67	79
FS20	AL20	FL20	20	M24	25.0	32.2	34.0	19.0	87	69	87
FS22	AL22	FL22	22	M27	26.0	36.0	37.5	21.0	91	73	91
FS26 *	AL26 *	FL26 *	25 / 26	M30	30.5	41.1	44.0	21.0	111	82	111
FS28	AL28	FL28	28	M33	31.5	45.5	48.0	24.0	117	87	117
FS30	AL30	FL30	30	M36	35.5	48.4	51.0	25.0	126	96	126
FS32	AL32	FL32	32	M39	36.5	52.1	54.0	26.0	131	99	131
FS34	AL34	FL34	34	M42	39.0	56.1	58.0	26.0	142	104	142
FS36	AL36	FL36	36	M42	40.0	57.8	61.0	27.0	150	107	150
FS40	AL40	FL40	40	M48	44.5	64.9	67.5	27.0	164	116	164

* Type 26 can be used for rebar Ø25mm & 26mm

ZENTOR® - Rebar Splicing System

Product Description - Left/Right Connection 'L'

Annex A6

Connection of bars with steel construction

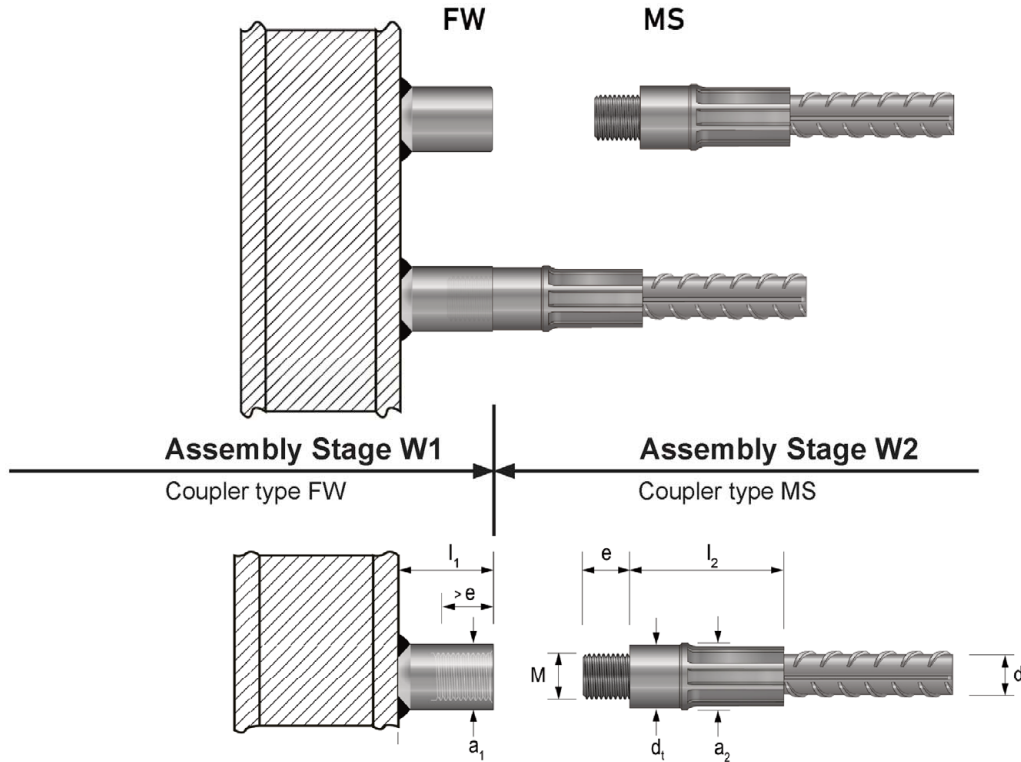

Coupler type		Rebar diameter d [mm]	Thread size M	Thread length e [mm]	Outer-Ø d _t [mm]	Outer-Ø a ₁ [mm]	Coupler length l ₁ [mm]	Outer-Ø a ₂ [mm]	Coupler length l ₂ [mm]
FW10	MS10	10	M12	13.5	15.6	20.0	31	17.5	48
FW12	MS12	12	M16	16.5	20.0	22.0	35	21.0	55
FW14	MS14	14	M18	20.0	23.4	26.0	39	25.0	66
FW16	MS16	16	M20	21.0	26.4	30.0	41	28.0	72
FW18	MS18	18	M22	24.0	28.7	32.0	45	31.0	79
FW20	MS20	20	M24	25.0	31.7	35.0	46	34.0	87
FW22	MS22	22	M27	26.0	35.5	40.0	48	37.5	91
FW26 *	MS26 *	25 / 26	M30	30.5	40.6	45.0	54	44.0	111
FW28	MS28	28	M33	31.5	45.0	50.0	55	48.0	117
FW30	MS30	30	M36	35.5	47.9	52.0	60	51.0	126
FW32	MS32	32	M39	36.5	51.6	58.0	61	54.0	131
FW34	MS34	34	M42	39.0	55.6	60.0	65	58.0	142
FW36	MS36	36	M42	40.0	57.3	64.0	66	61.0	150
FW40	MS40	40	M48	44.5	64.4	70.0	73	67.5	164

* Type 26 can be used for rebar Ø25mm & 26mm

ZENTOR® - Rebar Splicing System

Product Description - Welding Connection 'W'

Annex A7

Connection of bars with the same diameter, which are freely rotatable

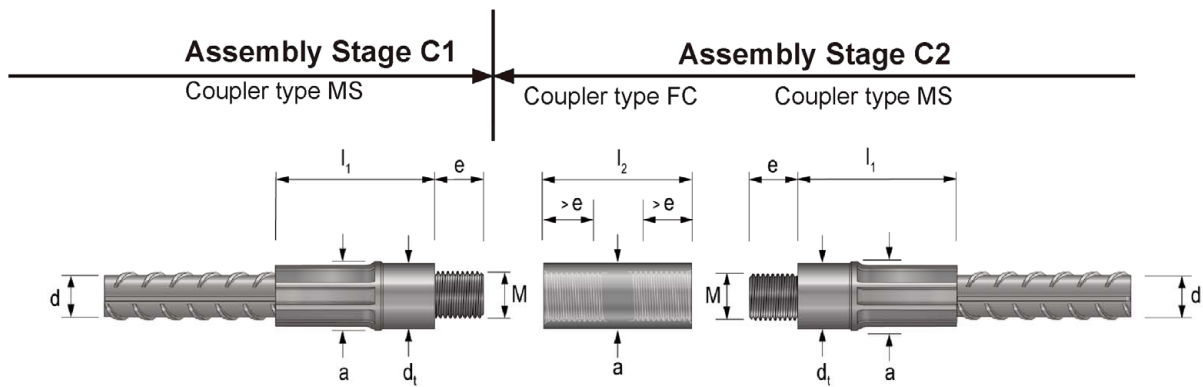
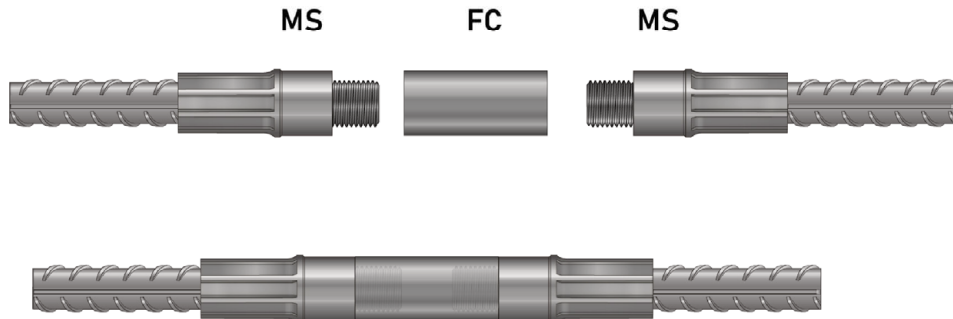

Coupler type			Rebar diameter	Thread size	Thread length	Outer-Ø	Outer-Ø	Coupler length	Coupler length
			d [mm]	M	e [mm]	a [mm]	dt [mm]	l ₁ [mm]	l ₂ [mm]
MS10	FC10	MS10	10	M12	13.5	17.5	15.6	48	31
MS12	FC12	MS12	12	M16	16.5	21.0	20.0	55	37
MS14	FC14	MS14	14	M18	20.0	25.0	23.4	66	45
MS16	FC16	MS16	16	M20	21.0	28.0	26.4	72	46
MS18	FC18	MS18	18	M22	24.0	31.0	28.7	79	53
MS20	FC20	MS20	20	M24	25.0	34.0	31.7	87	55
MS22	FC22	MS22	22	M27	26.0	37.5	35.5	91	57
MS26 *	FC26 *	MS26 *	25 / 26	M30	30.5	44.0	40.6	111	68
MS28	FC28	MS28	28	M33	31.5	48.0	45.0	117	70
MS30	FC30	MS30	30	M36	35.5	51.0	47.9	126	78
MS32	FC32	MS32	32	M39	36.5	54.0	51.6	131	80
MS34	FC34	MS34	34	M42	39.0	58.0	55.6	142	86
MS36	FC36	MS36	36	M42	40.0	61.0	57.3	150	88
MS40	FC40	MS40	40	M48	44.5	67.5	64.4	164	98

* Type 26 can be used for rebar Ø25mm & 26mm

ZENTOR® - Rebar Splicing System

Product Description - Coupler Connection 'C'

Annex A8

Intended Use

Mechanical Splicing System ZENTOR® according to EN 1992-1-1 and EN 1998-1 and Annex C.

- Transmission of static or quasi-static tension and compression loads according to EN 1992-1-1, clauses 8.7 and 8.8(4)
- Limitation of slip according to EN 1992-1-1, clause 7.3
- Transmission of high-cycle fatigue loads with fatigue resistance according to EN 1992-1-1, clause 6.8.4
- Resistance to low-cycle seismic loading according to EN 1998-1, clause 5.6.3(2)
- Welding Connection "W" is used to connect reinforcing steel bars with steel components. The load transmission from the reinforcing steel bar to the steel component via the welds has to be verified for each case by responsible engineer.

Installation Requirements

- Mechanical splices with ZENTOR® may be loaded up to 100% in the same way as non-spliced bar under static and quasi-static tensile and compression load, EN 1992-1-1, 8.7.2 (4) applies.
- With regard to the concrete cover to the outer edge of a coupler and the clear distance between two adjacent Coupler surfaces, the same values apply as for non-lapped bars according to EN 1992-1-1. Installation of the Splicing Systems ZENTOR® shall be done by trained staff and under the supervision of supervisor.
- Rebar coupler ZENTOR® are only allowed to connect with other ZENTOR® Rebar coupler.
- Before assembly, the threads shall be checked for damage. Only threads of the same size may be screwed together.
- Appropriate measures shall be taken to prevent cement or other contaminants from penetrating the female couplers.
- Bends in the rebar may only begin from a minimum distance of 5x rebar diameter, measured between the coupler the beginning of the bend.
- Installation of Rebar Splicing System acc. to Installation manual, Annex B2 and B3
- All threads shall be protected against penetration of water and dirt.
- In order to connect the Welding connection to a steel component, a welding procedure Specification WPS in accordance with EN ISO 15609-1 shall be available and shall be observed by the welding personnel. The welding manufacturer shall submit a welding certificate in accordance with the EN 1090-1, Table B.1. The welders must have valid welder's test certificates in accordance with EN ISO 9606-1 The welding coupler and the steel component shall be protected against corrosion in accordance with the applicable provisions, see EN ISO 12944-5.

Rebar Splicing System ZENTOR® must be tightened with the torque related to the diameter after assembly.

Rebar diameter [mm]	10/12	14/16	18/20	22	25/26	28/30/32	34/36	40
Torque [Nm]	60	80	100	140	200	240	260	280

It must be ensured that the torque wrenches are calibrated and comply with the normative specifications.

ZENTOR® - Rebar Splicing System

ZENTOR® - Intended Use and Installation Requirements

Annex B1

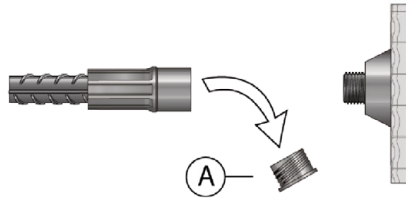

- Fasten the nail cone to the formwork
- Remove protection cap (A) from the coupler

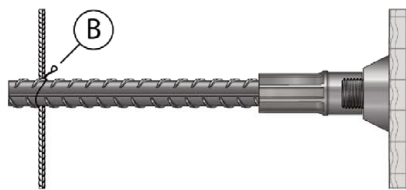

- Fasten the coupler onto the nail cone
- Fasten the rebar securely (B)

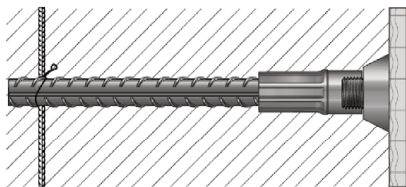

- Fill in concrete

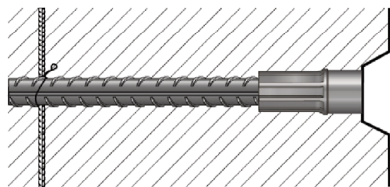

- Remove the formwork
- Remove the nail cone

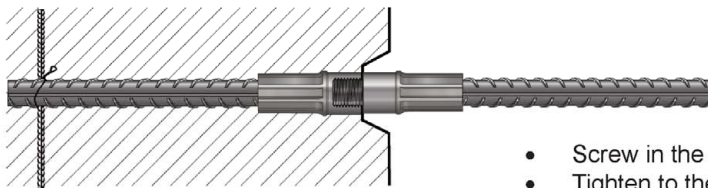

- Screw in the male coupler and fasten it securely
- Tighten to the prescribed torque

ZENTOR® - Rebar Splicing System

ZENTOR® - Intended Use and Installation manual for Connection 'S'

Annex B2

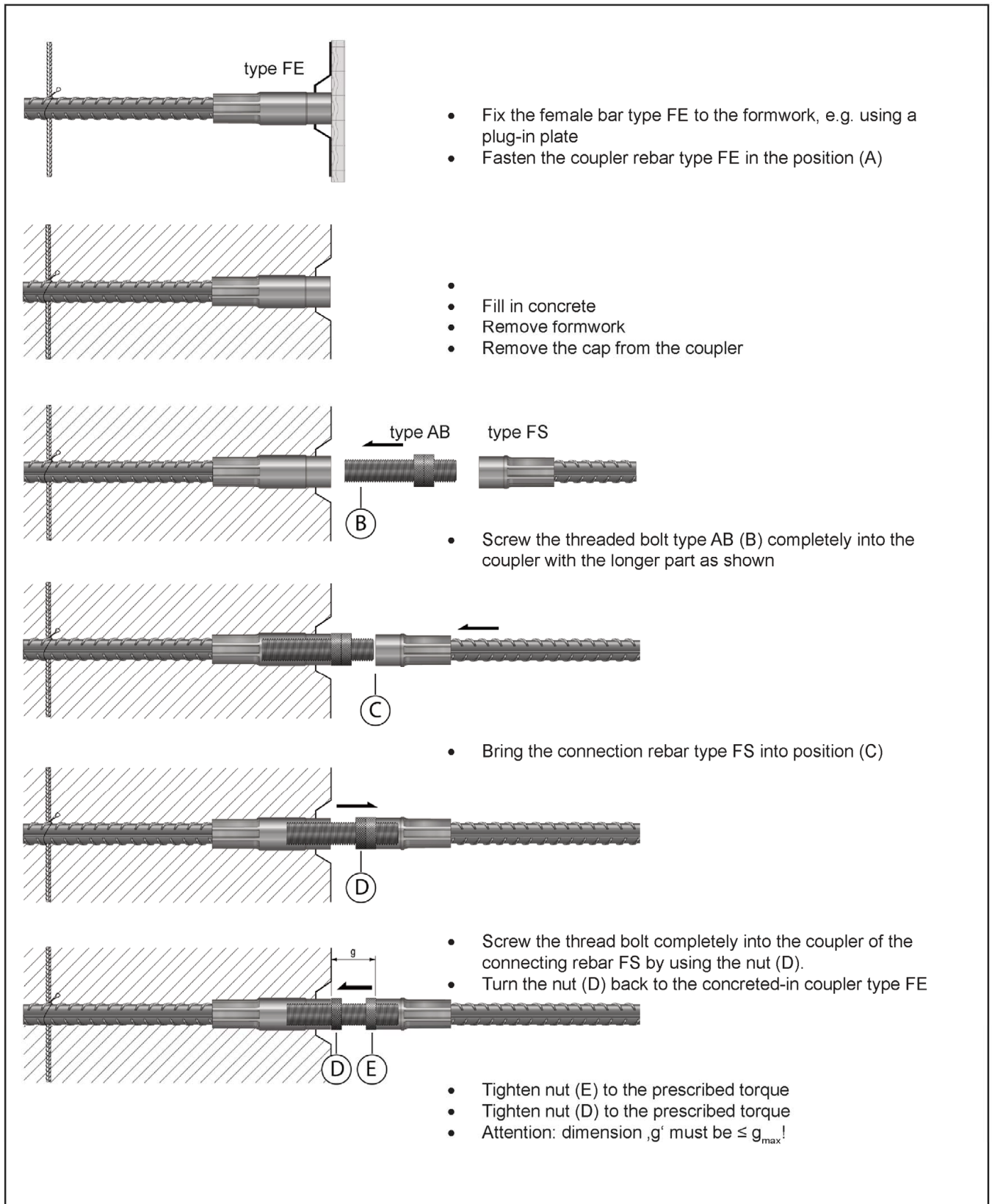

ZENTOR® - Rebar Splicing System

ZENTOR® - Intended Use and Installation manual for Connection 'B'

Annex B3

ZENTOR® - Standard Connection ,S' with Rebar B500B / B500C / B550B

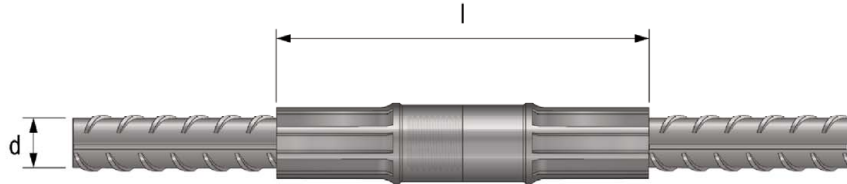

Combination	Nom. -Ø d [mm]	Length l [mm]	Slip value under static or quasi-static loading **) s ₁ [mm]	Resistance to static or quasi-static loading for B500B / B500C / B550B (tension and compression) *) f _{u,min,bar,outside} [N/mm ²]	Fatigue strength N = 2 · 10 ⁶ Δσ _{Rsk} [N/mm ²]	Slip value after static or quasi-static loading ***) s ₂ [mm]	Resistance to low-cycle loading (seismic action) for B500B / B500C ****)		Resistance to low-cycle loading (seismic action) for B550B ****)	
							u ₂₀ [mm]	F _{u,min} [kN]	u ₂₀ [mm]	F _{u,min} [kN]
FS10-MS10	10	96	0.10	540 / 575 / 594	62.4	< 0.10	0.20	0.20	0.20	46.7
FS12-MS12	12	110	0.11							67.2
FS14-MS14	14	132	0.12							91.4
FS16-MS16	16	144	0.12		119.4					
FS18-MS18	18	158	0.13		151.2					
FS20-MS20	20	174	0.14		186.6					
FS22-MS22	22	182	0.14		225.8					
FS26-MS26	25 / 26	222	0.16		315.4					
FS28-MS28	28	234	0.17		no performance assessed					
FS30-MS30	30	252	0.18							
FS32-MS32	32	262	0.18							
FS34-MS34	34	284	0.19							
FS36-MS36	36	300	0.20							
FS40-MS40	40	328	0.20		46.8					678.6

*) $f_{u,min,bar,outside} = f_{yk} \cdot 1,08$ with $f_{yk} = 500 \text{ N/mm}^2$ (B500B), resp. with $f_{yk} = 550 \text{ N/mm}^2$ (B550B)
 $f_{u,min,bar,outside} = f_{yk} \cdot 1,15$ with $f_{yk} = 500 \text{ N/mm}^2$ (B500C)
 **) Slip within the connection under loading measured at $0,6 \cdot f_{yk}$
 ***) Slip within the connection after loading measured at $0,02 \cdot f_{yk}$
 ****) $F_{u,min} = (\pi \cdot d^2) / 4 \cdot f_{u,min}$
 *****) The values given for nominal diameters 28 to 40 mm apply exclusively to B500C

ZENTOR® - Rebar Splicing System

Performance Parameter for Connection 'S'

Annex C1

ZENTOR® - Bridge Connection ,B' with Rebar B500B / B500C / B550B

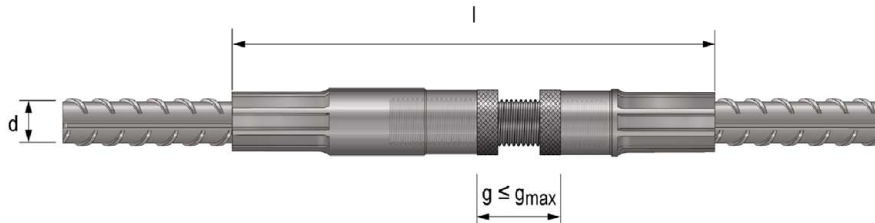

Combination	Nom. -Ø	Length with g_{min}	Slip value under static or quasi-static loading	Resistance to static or quasi-static loading for B500B / B500C / B550B (tension and compression)	Slip value after static or quasi-static loading
	d [mm]	l [mm]	s_1 [mm]	$f_{u,min,bar,outside}$ [N/mm ²]	s_2 [mm]
FE10-AB10-FS10	10	133	0.12	540 / 575 / 594	< 0.10
FE12-AB12-FS12	12	152	0.13		
FE14-AB14-FS14	14	182	0.14		
FE16-AB16-FS16	16	198	0.15		
FE18-AB18-FS18	18	220	0.16		
FE20-AB20-FS20	20	239	0.17		
FE22-AB22-FS22	22	250	0.18		
FE26-AB26-FS26	25 / 26	300	0.20		
FE28-AB28-FS28	28	315	0.20		
FE30-AB30-FS30	30	346	0.20		
FE32-AB32-FS32	32	362	0.20		
FE34-AB34-FS34	34	389	0.20		
FE36-AB36-FS36	36	404	0.20		
FE40-AB40-FS40	40	443	0.20		

*) $f_{u,min,bar,outside} = f_{yk} \cdot 1,08$ with $f_{yk} = 500 \text{ N/mm}^2$ (B500B), resp. with $f_{yk} = 550 \text{ N/mm}^2$ (B550B)

$f_{u,min,bar,outside} = f_{yk} \cdot 1,15$ with $f_{yk} = 500 \text{ N/mm}^2$ (B500C)

***) Slip within the connection under loading measured at $0,6 \cdot f_{yk}$

***) Slip within the connection after loading measured at $0,02 \cdot f_{yk}$

ZENTOR® - Rebar Splicing System

Performance Parameter for Connection 'B'

Annex C2

ZENTOR® - Female Reduction Connection ,F' with Rebar B500B / B500C / B550B

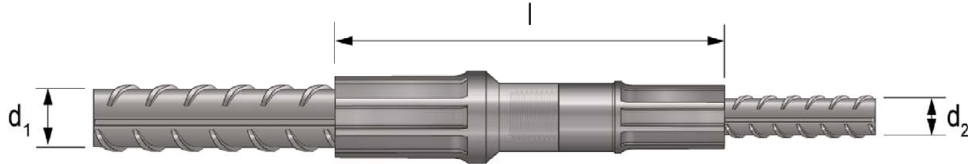

Combination	Nom. -Ø		Length l [mm]	Slip value under static or quasi-static loading	Resistance to static or quasi-static loading for B500B / B500C / B550B (tension and compression)	Slip value after static or quasi-static loading
	d ₁ [mm]	d ₂ [mm]		s ₁ [mm]	f _{u,min,bar,outside} [N/mm ²]	s ₂ [mm]
FR1210-MS10	12	10	102	0.10	540 / 575 / 594	< 0.10
FR1410-MS10	14	10	112	0.11		
FR1612-MS12	16	12	124	0.11		
FR1812-MS12	18	12	131	0.12		
FR2014-MS14	20	14	153	0.13		
FR2216-MS16	22	16	163	0.13		
FR2620-MS20	25 / 26	20	196	0.15		
FR2820-MS20	28	20	204	0.15		
FR3020-MS20	30	20	213	0.16		
FR3226-MS26	32	25 / 26	243	0.17		
FR3426-MS26	34	25 / 26	254	0.18		
FR3628-MS28	36	28	264	0.18		
FR4030-MS30	40	30	290	0.20		

*) $f_{u,min,bar,outside} = f_{yk} \cdot 1,08$ with $f_{yk} = 500 \text{ N/mm}^2$ (B500B), resp. with $f_{yk} = 550 \text{ N/mm}^2$ (B550B)

$f_{u,min,bar,outside} = f_{yk} \cdot 1,15$ with $f_{yk} = 500 \text{ N/mm}^2$ (B500C)

**) Slip within the connection under loading measured at $0,6 \cdot f_{yk}$

***) Slip within the connection after loading measured at $0,02 \cdot f_{yk}$

ZENTOR® - Rebar Splicing System

Performance Parameter for Connection 'F'

Annex C3

ZENTOR® - Transition Connection ,T' with Rebar B500B / B500C / B550B

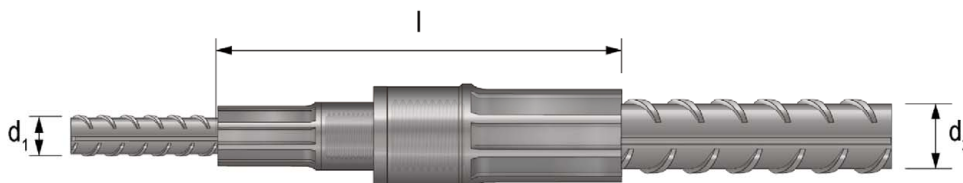

Combination	Nom. -∅		Length l [mm]	Slip value under static or quasi-static loading	Resistance to static or quasi-static loading for B500B / B500C / B550B (tension and compression)	Slip value after static or quasi-static loading
	d ₁ [mm]	d ₂ [mm]		s ₁ [mm]	f _{u,min,bar,outside} [N/mm ²]	s ₂ [mm]
FS10-AT1012-FS12	10	12	106	0.10	540 / 575 / 594	< 0.10
FS10-AT1014-FS14	10	14	118	0.11		
FS12-AT1216-FS16	12	16	131	0.12		
FS12-AT1218-FS18	12	18	139	0.12		
FS14-AT1420-FS20	14	20	158	0.13		
FS16-AT1622-FS22	16	22	168	0.13		
FS20-AT2026-FS26	20	25 / 26	203	0.15		
FS20-AT2028-FS28	20	28	209	0.15		
FS20-AT2030-FS30	20	30	218	0.16		
FS26-AT2632-FS32	25 / 26	32	247	0.17		
FS26-AT2634-FS34	25 / 26	34	258	0.18		
FS28-AT2836-FS36	28	36	271	0.19		
FS30-AT3040-FS40	30	40	295	0.20		

*) $f_{u,min,bar,outside} = f_{yk} \cdot 1,08$ with $f_{yk} = 500 \text{ N/mm}^2$ (B500B), resp. with $f_{yk} = 550 \text{ N/mm}^2$ (B550B)

$f_{u,min,bar,outside} = f_{yk} \cdot 1,15$ with $f_{yk} = 500 \text{ N/mm}^2$ (B500C)

**) Slip within the connection under loading measured at $0,6 \cdot f_{yk}$

***) Slip within the connection after loading measured at $0,02 \cdot f_{yk}$

ZENTOR® - Rebar Splicing System

Performance Parameter for Connection 'T'

Annex C4

ZENTOR® - Left/Right Connection ,L' with Rebar B500B / B500C / B550B

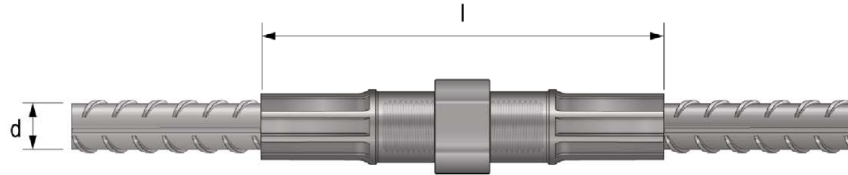

Combination	Nom. -Ø	Length	Slip value under static or quasi-static loading	Resistance to static or quasi-static loading for B500B / B500C / B550B (tension and compression)	Slip value after static or quasi-static loading
	d [mm]	l [mm]	s ₁ [mm]	f _{u,min,bar,outside} [N/mm ²]	s ₂ [mm]
FS10-AL10-FL10	10	111	0.11	540 / 575 / 594	< 0.10
FS12-AL12-FL12	12	126	0.11		
FS14-AL14-FL14	14	148	0.12		
FS16-AL16-FL16	16	162	0.13		
FS18-AL18-FL18	18	177	0.14		
FS20-AL20-FL20	20	193	0.15		
FS22-AL22-FL22	22	203	0.15		
FS26-AL26-FL26	25 / 26	243	0.17		
FS28-AL28-FL28	28	258	0.18		
FS30-AL30-FL30	30	277	0.19		
FS32-AL32-FL32	32	288	0.19		
FS34-AL34-FL34	34	310	0.20		
FS36-AL36-FL36	36	327	0.20		
FS40-AL40-FL40	40	355	0.20		

*) $f_{u,min,bar,outside} = f_{yk} \cdot 1,08$ with $f_{yk} = 500 \text{ N/mm}^2$ (B500B), resp. with $f_{yk} = 550 \text{ N/mm}^2$ (B550B)

$f_{u,min,bar,outside} = f_{yk} \cdot 1,15$ with $f_{yk} = 500 \text{ N/mm}^2$ (B500C)

***) Slip within the connection under loading measured at $0,6 \cdot f_{yk}$

***) Slip within the connection after loading measured at $0,02 \cdot f_{yk}$

ZENTOR® - Rebar Splicing System

Performance Parameter for Connection 'L'

Annex C5

ZENTOR® - Connection ,C' with Rebar B500B / B500C / B550B

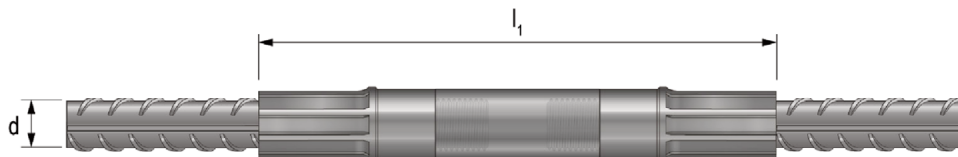

Combination	Nom. -Ø d [mm]	Length l [mm]	Slip value under static or quasi-static loading **) s ₁ [mm]	Resistance to static or quasi-static loading for B500B / B500C / B550B (tension and compression) *) f _{u,min,bar,outside} [N/mm ²]	Slip value after static or quasi-static loading ***) s ₂ [mm]
MS10-FC10-MS10	10	127	0.11	540 / 575 / 594	< 0.10
MS12-FC12-MS12	12	147	0.12		
MS14-FC14-MS14	14	177	0.14		
MS16-FC16-MS16	16	190	0.15		
MS18-FC18-MS18	18	211	0.16		
MS20-FC20-MS20	20	229	0.16		
MS22-FC22-MS22	22	239	0.17		
MS26-FC26-MS26	25 / 26	290	0.20		
MS28-FC28-MS28	28	304	0.20		
MS30-FC30-MS30	30	330	0.20		
MS32-FC32-MS32	32	342	0.20		
MS34-FC34-MS34	34	370	0.20		
MS36-FC36-MS36	36	388	0.20		
MS40-FC40-MS40	40	426	0.20		

*) $f_{u,min,bar,outside} = f_{yk} \cdot 1,08$ with $f_{yk} = 500 \text{ N/mm}^2$ (B500B), resp. with $f_{yk} = 550 \text{ N/mm}^2$ (B550B)

$f_{u,min,bar,outside} = f_{yk} \cdot 1,15$ with $f_{yk} = 500 \text{ N/mm}^2$ (B500C)

***) Slip within the connection under loading measured at $0,6 \cdot f_{yk}$

****) Slip within the connection after loading measured at $0,02 \cdot f_{yk}$

ZENTOR® - Rebar Splicing System

Performance Parameter for Connection 'C'

Annex C6

ZENTOR® - Welding Connection ,W' with Rebar B500B / B500C / B550B

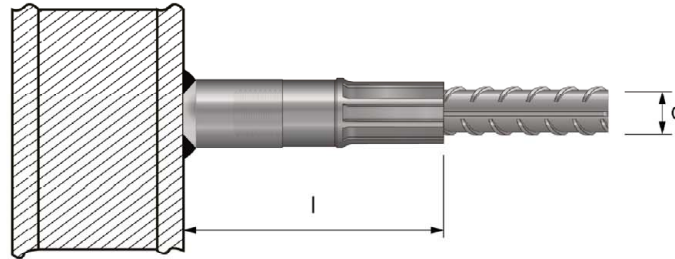

Combination	Nom. -Ø	Length	Slip value under static or quasi-static loading	Resistance to static or quasi-static loading for B500B / B500C / B550B (tension and compression)	Slip value after static or quasi-static loading
	d [mm]	l [mm]	s ₁ [mm]	f _{u,min,bar,outside} [N/mm ²]	s ₂ [mm]
FW10-MS10	10	79	0.10	540 / 575 / 594	< 0.10
FW12-MS12	12	90	0.10		
FW14-MS14	14	105	0.10		
FW16-MS16	16	113	0.10		
FW18-MS18	18	124	0.10		
FW20-MS20	20	133	0.10		
FW22-MS22	22	139	0.10		
FW26-MS26	25 / 26	165	0.11		
FW28-MS28	28	172	0.11		
FW30-MS30	30	186	0.11		
FW32-MS32	32	192	0.12		
FW34-MS34	34	207	0.12		
FW36-MS36	36	216	0.13		
FW40-MS40	40	237	0.13		

*) $f_{u,min,bar,outside} = f_{yk} \cdot 1,08$ with $f_{yk} = 500 \text{ N/mm}^2$ (B500B), resp. with $f_{yk} = 550 \text{ N/mm}^2$ (B550B)

$f_{u,min,bar,outside} = f_{yk} \cdot 1,15$ with $f_{yk} = 500 \text{ N/mm}^2$ (B500C)

***) Slip within the connection under loading measured at $0,6 \cdot f_{yk}$

****) Slip within the connection after loading measured at $0,02 \cdot f_{yk}$

ZENTOR® - Rebar Splicing System

Performance Parameter for Connection 'W'

Annex C7